

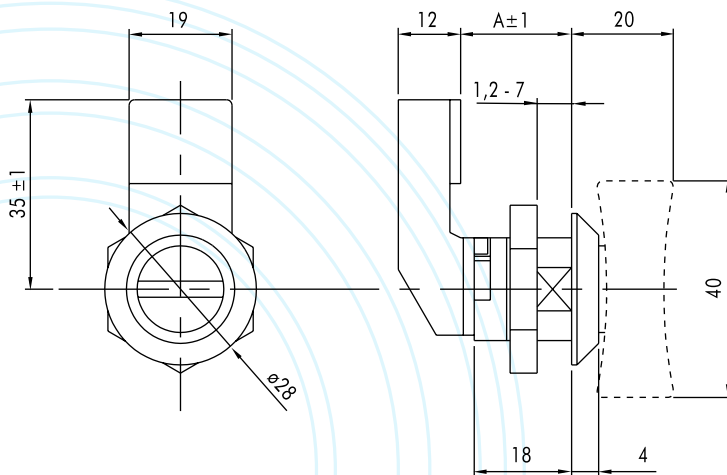

Fecho Lingueta em Poliamida com porca de fixação

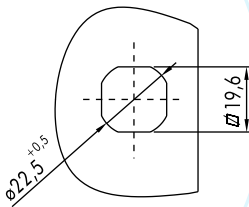



DESENHOS

FURAÇÃO PARA MONTAGEM

CARACTERÍSTICAS TÉCNICAS:

- *FABRICADO EM POLIAMIDA PRETA REFORÇADA COM FIBRA DE VIDRO: MANOPLA, MIOLO, BUCHA, LINGUETA E PORCA DE FIXAÇÃO
- *FÁCIL INSTALAÇÃO SEM NECESSIDADE DE DESMONTAGEM DA LINGUETA
- *FIXAÇÃO ATRAVÉS DE PORCA
- *ABERTURA DIREITA/ESQUERDA
- *VEDAÇÃO IP 65

CÓDIGO

MEDIDA DA LINGUETA (A)					
	MIOLO TRIÂNGULO	MIOLO QUADRADO	MIOLO UNIVERSAL	MIOLO FENDA	MANOPLA BORBOLETA
18 mm	FL 30052	FL 31052	FL 32052	FL 39052	FL 32152
20 mm	FL 50052	FL 52052	FL 54052	FL 56052	FL 58052
22 mm	FL 70052	FL 71052	FL 72052	FL 73052	FL 74052
24 mm	FL 90052	FL 91052	FL 92052	FL 93052	FL 94052
26 mm	FL 10052	FL 11052	FL 12052	FL 13052	FL 14052
28 mm	FL 33052	FL 34052	FL 35052	FL 36052	FL 37052
30 mm	FL 51052	FL 53052	FL 55052	FL 57052	FL 59052

PRETO

ATENÇÃO: As chaves e as chapas estampadas são vendidas separadamente.